

А с т е к



Инструкция по сборке

Фронтальный приставной элемент
для парт-трансформеров:

Арт. 202.04.0 (25x115) - для TWIN и MONO

Арт. 202.06.0 (25x80) - для КОЛИБРИ



Необходимый инструмент



Фурнитура

A 2x M6x40	B 2x M6x15	C 8x 4x35	D 10x φ5	202.04.0XX ТВИН и МОНО
A 2x M6x40	B 2x M6x15	C 8x 4x35	D 8x φ5	202.06.0XX Колибри

Комплектующие

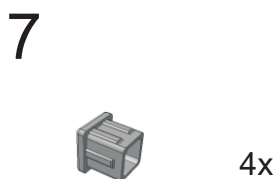
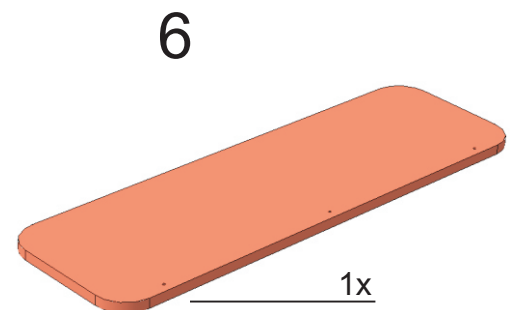
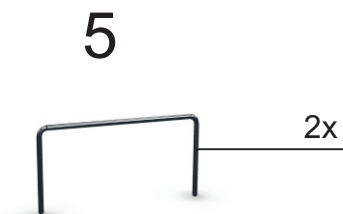
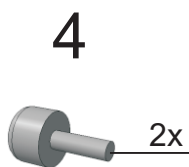
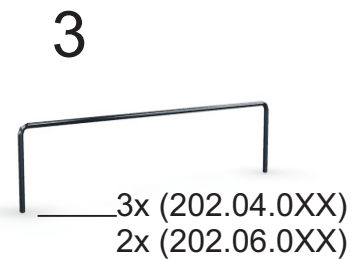
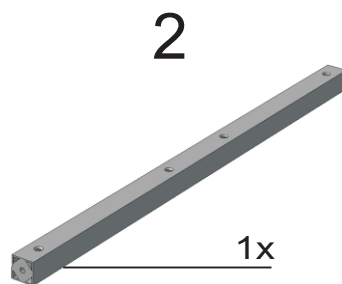
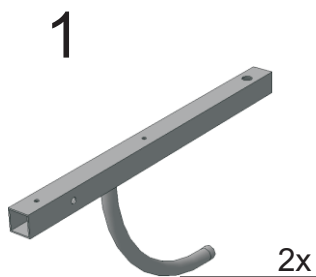

1

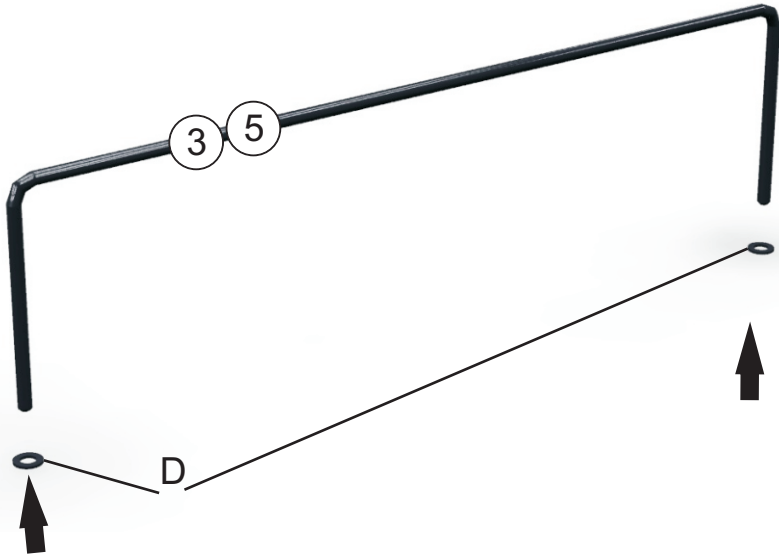

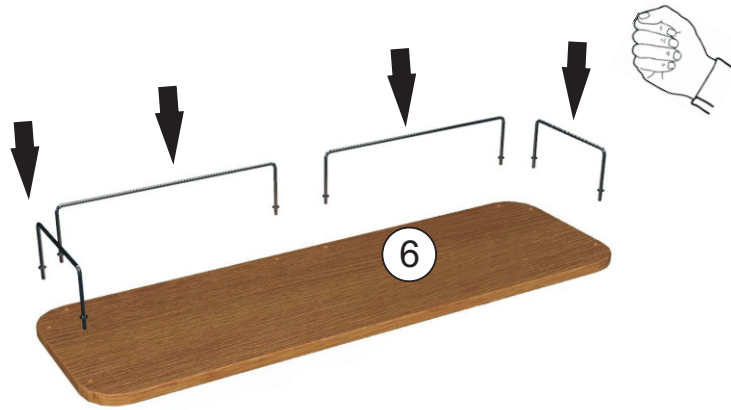

202.04.0XX	D	
	10x	φ5
202.06.0XX	D	
	8x	φ5

2

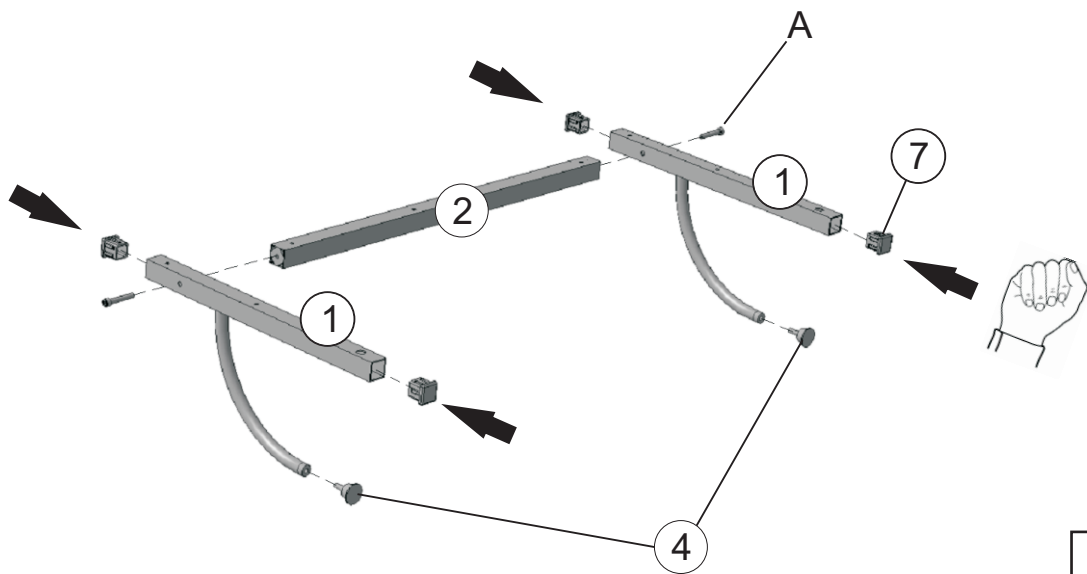

3



A	
2x	M6x40

4

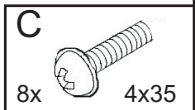
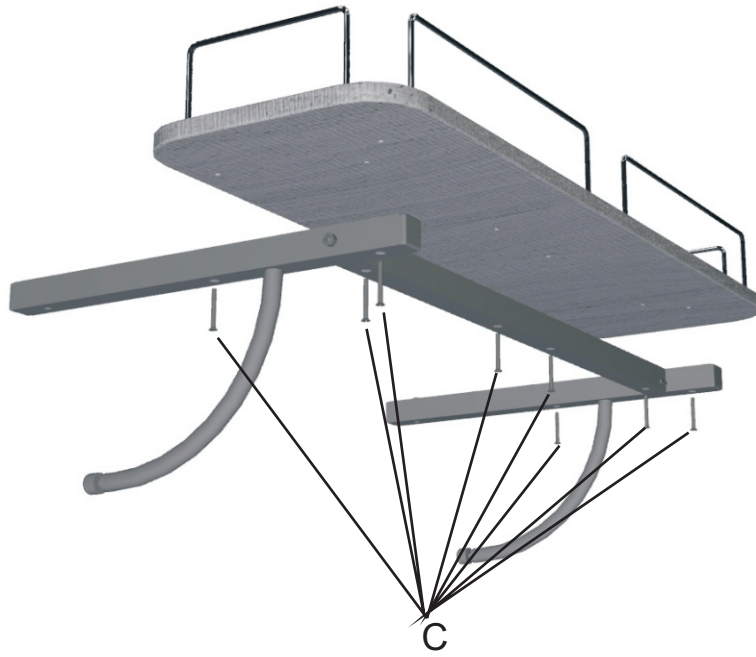

5

